

INSTRUCTION MANUAL

Manufacturer:

Haynl-Elektronik GmbH
Magdeburger Straße 117a
D-39218 Schönebeck
Germany



Mikti₂

Inhalt

IMPORTANT	4
Intended use	4
Medical application areas	4
SAFETY AND WARNING INSTRUCTIONS	5
Explanation of graphic symbols and product markings.....	5
Safety instructions	6
MODE OF OPERATION AND CONFIGURATION	11
Scope of delivery	11
Optional accessories	11
TECHNICAL DESCRIPTION	12
Device layout & accessories	12
Environmental conditions during use	15
TRAINING	16
Preparations	16
Preparing electrodes	17
Program selection	18
EMG-Setting	19
Exercise process	20
EMG-biofeedback training.....	21
Finishing a therapy session.....	25
MAINTENANCE	26
Maintaining electrodes	26
Maintaining the device.....	26
Replacing batteries.....	27
Safety checks	28
Troubleshooting.....	28
Storage and transport.....	29
ENVIRONMENTAL PROTECTION & DISPOSAL	30
TECHNICAL INFORMATION	31
Display	31
Connection ports	31
Modes of operation.....	31
EMG-Range.....	31
Exercise phases	31

Power supply	32
Safety features	32
Operating conditions	33
Dimensions and weight	33
Storage of exercise data	33
Application recommendation	34
ELECTROMAGNETIC COMPATIBILITY (EMC) TABLES	35
Warranty	39

ADVANCED INFORMATION FOR PHYSICIANS AND THERAPIST	40
Therapy Settings	41
System Settings.....	44
Administration.....	47

1st edition, February 2016

This instruction manual contains copyright protected information of Haynl-Elektronik GmbH and third parties. Each rendition or utilization outside of the borders permitted by copyright is inadmissible without previous written permission on the part of Haynl-Elektronik GmbH. Haynl-Elektronik GmbH reserves the right to make improvements and changes without prior notice. All data and information is reviewed periodically and any changes applied will be implemented in the next available version of the instruction manual.

The Bluetooth® brand name and logo are property of Bluetooth SIG, Inc. All usage of this trademark by Haynl-Elektronik GmbH is covered under a license agreement. Other trademarks may contain property of other owners.

IMPORTANT

PLEASE READ ALL INFORMATION PROVIDED IN THIS INSTRUCTION MANUAL BEFORE USING THE MIKTI₂ MEDICAL DEVICE OR ANY OF ITS ACCESSORIES.

THIS INSTRUCTION MANUAL IS AN INTEGRAL PART OF THE MEDICAL DEVICE.

PLEASE STORE THIS MANUAL WITH THE MEDICAL DEVICE.

Do not use Mikti₂ if you do not fully understand any aspect of operating the device. Please refer to a qualified supplier for assistance.

Intended use

The electrotherapy device Mikti₂ is a class IIa medical device. The Mikti₂ is a therapy equipment especially for Children. The therapy bases on the biofeedback technology.

Medical application areas

The Mikti₂ therapy device is designed for the treatment of patients afflicted with stress incontinence, fecal incontinence, detrusor sphincter dyssynergia and for postoperative training after corrective surgery for anorectal malformations (ARMs) in children.

Safety and warning instructions

Explanation of graphic symbols and product markings



Indicates a major hazard that poses a high risk of death or serious injury if not avoided.



Indicates a significant hazard that poses a medium risk of death or serious injury if not avoided.



Indicates a minor hazard that poses a risk of medium to minor injuries if not avoided.



Consult instruction manual



Manufacturer



Serial number



Application part Type BF



„On“/„Off“

CE 0123

CE-marking and identification number of notified body involved



Caution – follow instructions



Protect medical device from moisture



Protect device from direct sunlight and heat



Do not dispose of medical device along with normal/household waste



Not suitable for pacemaker wearers



Prevention of danger/risk

Safety instructions



DANGER

Danger to patients with cardiac damage

- ➔ Mikti₂ should not be used by patients with cardiac damage unless with explicit permission given by a medical specialist.

Danger to untrained children and untrained users

- ➔ Store device at a secure location.

Deviation of electrical output by unauthorized repair attempts

- ➔ Do neither open nor attempt to repair the device.

Risk of igniting highly flammable substances

- ➔ Keep the device away from easily flammable materials.

Usage by multiple patients:

Health risks due to contamination, chemical residues and changes of functional performance

- ➔ Requires validated processes in accordance with latest legal requirements to prepare the device for use by a different patient.

Damage to health caused by incorrect use of device

- Only use the device as per the instructions given in this manual at all times. Always store this manual together with the device.



WARNING

Risk of skin burns due to high-frequency surgery equipment

- Simultaneous use of a surgical device employing high frequencies and this device may cause burns at contact points between skin and electrodes.

Risk of infection

- Any accessories may only be used by a single patient.

Risk of flammable/explosive substances being ignited

- Do not operate the device near flammable/explosive substances or flames of any type.

Deviation of electrical output due to ambient conditions

- Ensure that the recommended environmental conditions for using and storage of the device are not exceeded.

Risk of infection for patients designated to use sterile products only

- Do not use the device if sterile environmental conditions are required for a patient.

Danger due to erratic or involuntary movements

Do not use the device with patients suffering from seizure disorders (e.g. epilepsy), increased epileptogenicity or severe cognitive impairments unless with explicit permission given by a medical specialist.

Risk of electrical shock or injury caused by non-approved accessories

- ➔ Only use approved accessories with the device.

Risk due to improper use

- ➔ Do not connect Mikti₂ with any accessories or medical devices other than those approved by the manufacturer.

Risk of electrical shock from electricity grid

- ➔ Do not connect the device, any of its parts or accessories with the electricity grid.



CAUTION

Deviation of electrical output in the proximity of therapeutic shortwave or microwave devices

- ➔ Do not operate the device near therapeutic shortwave or microwave devices.

Pain or physical discomfort during treatment

- ➔ Stop using the device immediately, consult the medical specialist in charge of the treatment and notify the manufacturer.

Danger of injury due to damaged accessories

- ➔ Avoid pulling on connection cables or applying excessive force to any part of the accessories. Do not use any damaged accessories.

Danger of injury due to damaged device casing

- ➔ Avoid damaging the device casing by applying excessive force. Do not drop the device. Do not use damaged devices.

Danger of injury by electrical shock at the start and end of a therapy session

- ➔ Only turn the device on after all accessories have been connected. Do not remove any accessories before the device has been switched off.

Danger of injury by electrical shock when changing batteries

- ➔ Change batteries only after device has been switched off and all accessories removed.

Danger of injury by electrical shock

- ➔ Do not switch device on while battery compartment is open.

Danger of injury due to surgical wounds, skin injuries or skin irritations

- ➔ Do not place electrodes on or near any skin injuries, skin irritations, open wounds or fresh surgical wounds.

Danger to health due to infectious diseases or fever

- ➔ Do not use device.

Danger of injury while operating machinery

- ➔ Do not use device while operating machinery of any kind.

Danger of health impairments for patients suffering from polyneuropathy or peripheral nerve lesion in the region of the pelvic floor

- ➔ Do not use device.

Danger of triggering allergies

- ➔ Do not use device or its accessories if patient is allergic to gold or plastics.

Danger of bleedings due to haemorrhoid related illnesses

- ➔ Do not use device or accessories unless with explicit permission given by a medical specialist.

Mode of operation and configuration

Scope of delivery

 WARNING
Danger of infection → Any accessories may only be used by a single patient.

The Mikti₂ therapy device is delivered as a set containing the following items:

- 1x Mikti₂ (HPS12)
- 4x AA - Battery
- 1x INSTRUCTION MANUAL

Optional accessories

A number of optional items for use together with the Mikti₂ are available. Some of them are required in order to perform certain treatment exercises while others enhance the general function of the device. The following items are available:

- Type I: 4 sticking electrodes 4x4cm angular
- Type II: 24 sticking electrodes ø 2cm round
- Three pole cable K1 (MED), 2mm plug
- Three pole cable K3 (MED), 1.5mm plug
- Contact gel
- HPS-Software for creating new exercises and viewing exercise collected data
- Medical USB-cable for PC connection
- 4x NiMH rechargeable batteries (2500 mAh)
- 1x external battery recharger

Further sensor types are available on request.

Technical description

Device layout & accessories

Front

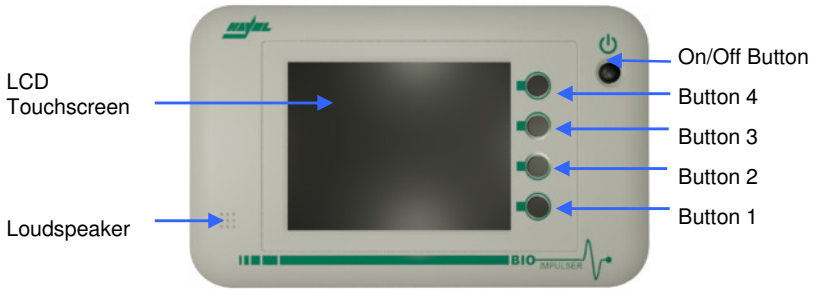

Top

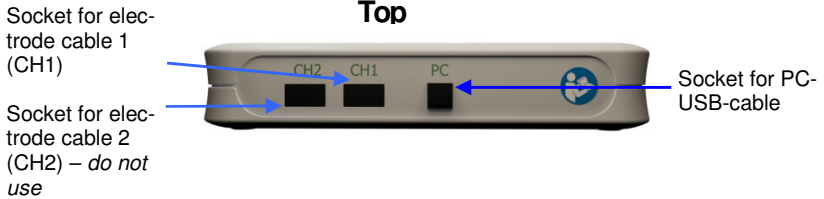

Back

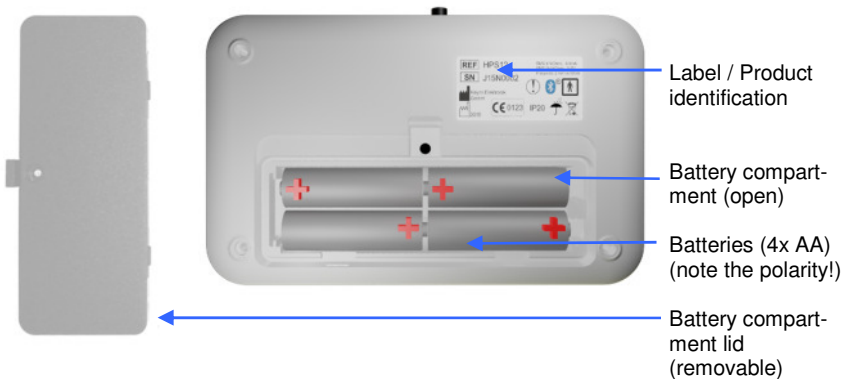

Electrodes with K1 (MED) electrode cable

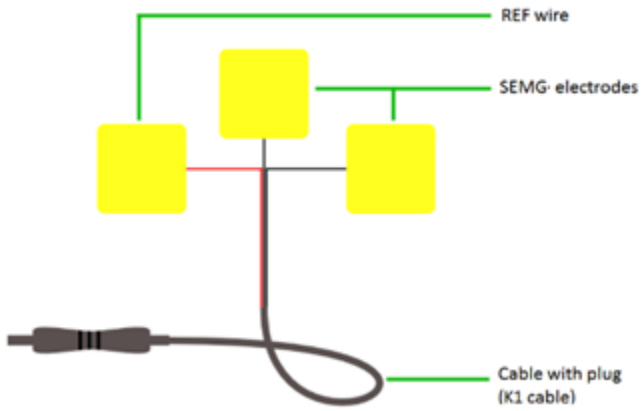

Overview of functions and signals

Acoustic signals

-)) Single short beep: button pressed
-)))) Two short beeps: batteries low, device will turn off

Optical signals and icons

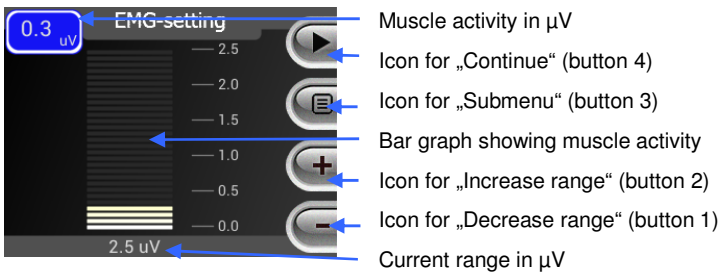

Environmental conditions during use



CAUTION



Danger to operator/user due to defective device

→ Medical device may only be operated at an ambient temperature between 5°C and 35°C.



→ Protect device from exposure to moisture.



→ Protect device from strong sunlight and strong sources of heat.

→ Do not use device in dusty environment.



→ Medical device may only be operated at a relative humidity of 30-75%.



→ Medical device may only be operated at a relative pressure of 700-1060 hPa.

Training

Preparations

Please choose a quiet and relaxed environment for therapy sessions. You should be able to sit comfortable or lie down. Avoid the proximity of TV sets, loudspeakers, fluorescent lamps or similar devices. The Mikti₂ medical device is equipped highly sensitive sensors. As such strong electromagnetic fields may cause significant errors during measurements despite appropriate shielding.

Before starting a training session the device needs to be turned off.

Please read the passage *Preparing electrodes*.

The treatment should never feel unpleasant or painful; however, a clear electrical tingling sensation should be felt.

Preparing electrodes

- Thoroughly clean the skin areas where the electrodes are to be placed. The skin needs to be dry and hairless. Use contact gel to improve conductivity and adhesion between skin and electrodes.
- Only apply electrodes to skin areas as recommended by the medical specialist responsible for the treatment.
- Connect the device plug of the connection cable with the *CH1 socket* on the device.
- Connect the electrode plugs of the connection cable with the electrodes.
- Turn the device on by pressing the *On/Off button*.

Program selection

After turning the device on by pressing the *On/Off button* it will display a boot screen. Once finished booting its screen will show a selection of programs to choose from. The program selection may cover two screens if four or more programs are available.

Press *Buttons 2 to 4* to start the treatment program displayed next to it. Press *Button 1* to switch between the screens of the program selection. Only one program may be started at a time.

The background color of a treatment program indicates its mode of operation:

- Blue: EMG-Biofeedback



Details concerning each program are displayed below their names. This includes the length of different parts of each program such as Tense (AZ) and Relax (EZ) phases in seconds.

After a program has been selected further instructions specific to its operation mode are given. Afterwards the actual treatment will begin.

EMG-Setting

Please follow these instructions to configure the EMG-scale in accordance with the EMG-mode set:

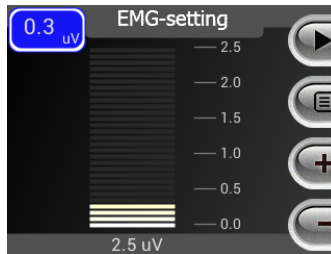

- **Manual EMG-Setting**
Begin by tensing the appropriate muscle regions as strongly as possible. While doing so adjust the EMG-scale with *button 1 & 2* until roughly $\frac{3}{4}$ of the scale is filled (see illustration above).
- **Semi-automatic EMG-Setting**
Tense the appropriate muscle regions as strongly as possible. The EMG-scale will adjust automatically to the best possible range. This process takes about two seconds on average to finish.
- **Automatic EMG-Setting**
EMG-scale will be adjusted dynamically during the exercise. As such the EMG-scale does not have to be set.

Exercise process

After all necessary preparations are complete the actual exercise will begin.

The details of the training may differ according to the recommendations made by the medical specialist responsible for the treatment.

Several different animations for visualizing muscle activity are available during exercise phases which measure said muscle activity. In order to switch to the next animation simply press *button 4* during relax or tense phase of the training.

The option to switch between different animations may be disabled. In this case the device is locked with a single animation.

EMG-biofeedback training

- Follow the instructions described under *Preparations, Program selection* and *EMG-Setting*.
- The training consists of two alternating phases:
 - Relax



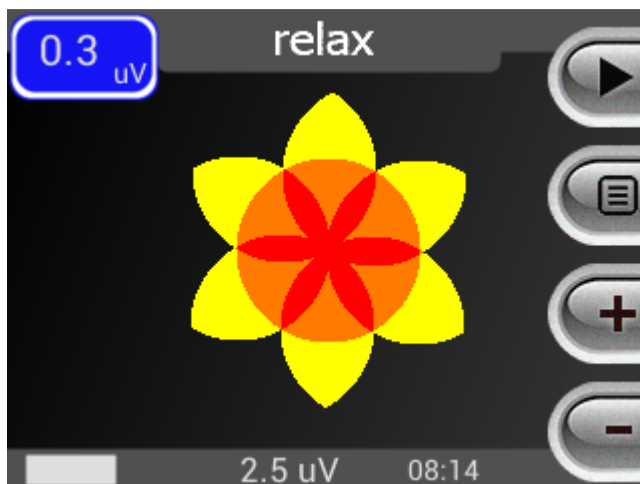

- Tense



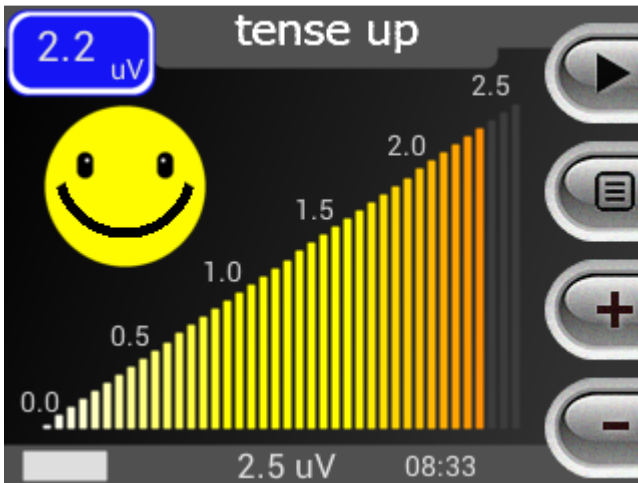

- Follow the instructions and passively relax or actively tense the relevant muscles.

Finishing a therapy session

- The training can be stopped at any time by pressing the *On/Off button*.
- If an exercise duration has been set the device will end the training session on its own once the training duration has been reached.
- Once the device has been turned off, pull the electrode cables from their sockets and remove the electrodes. Please store the electrodes as described under *Maintaining electrodes*.

Maintenance

Maintaining electrodes

In case the self-adhesive electrodes no longer stick to skin, moisten the sticky side with a few water drops.

Note that before placing electrodes on skin, the relevant skin areas should be cleaned with soapy water or an alcohol wipe.

Maintaining the device

Use a dry, soft cloth to clean the device of light stains. Do not use aggressive or abrasive cleaning agents of any kind. In case of tougher stains use soapy water or washing lotion in addition to a soft, moist cloth. Take care that no water enters any of the sockets or battery compartment. Dry the device afterwards, again with a soft cloth.



CAUTION

Hazard due to defective device

- ➔ Never clean the device under running water.
- ➔ Keep sockets and cable jacks dry at all times.

Replacing batteries

Under ideal circumstances one set of batteries will last a Mikti₂ for approximately 10 hours of use.

When the battery charge is getting too low the device will announce this with a double beep warning before turning off.

By default the device is delivered with one set of batteries. To replace the batteries unlock and open the *Battery compartment* on the back of the device.

Pay close attention to the polarity of the new batteries as you place them within the device. See the picture below for the correction alignment of the batteries.

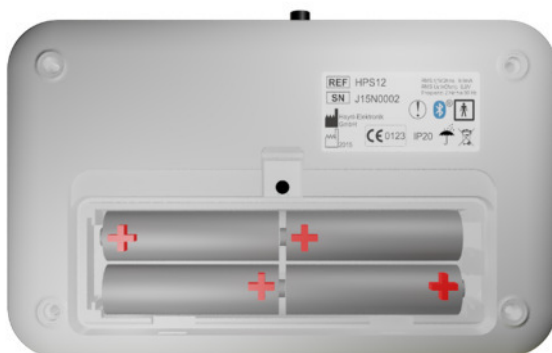

Once all batteries have been replaced close the battery compartment again.

Rechargeable batteries are available as optional accessories. These can be recharged with an external battery charger. Removing and placing them back in the device is done in the same way as with regular batteries.

Please only recharge these batteries once they are completely empty, as indicated by the device turning off with two beep noises.

Recharging batteries when they still carry much charge can damage them and make it necessary to replace them early on.

Safety checks

The Contiva+₂ has been manufactured in accordance with the Medical Devices Act and accordingly does not require any safety checks. For details of the applicable standard in your country please contact the local distributor or the manufacturer of this medical device.

Troubleshooting

See the table below if the device shows any errant behavior.

Please note that only specially trained persons may conduct repairs on the device and its accessories.

Error	Cause	Solution
No measurable EMG-signal	No connection between sensor cable and <i>sensor socket</i>	Check that the cable plug is correctly connected with the <i>sensor socket CH1</i>
	Insufficient contact between skin and electrode	Use new electrodes or use contact gel on the sticky side of the electrodes
	EMG-Range is set too high	Select a smaller EMG-Range (see <i>EMG-Setting</i>)
EMG-Signal overflow (scale	No EMG-signal – see above	See above

completely filled)	EMG-Range is too small	Select a larger EMG-Range (see <i>EMG-Setting</i>)
	Strong electromagnetic fields are causing interference	Change location to somewhere clear of such interference
Device lasts less than two hours with fully charged batteries	Batteries are defective	Replace batteries
Device does not turn on	Batteries are fully discharged	Replace/charge batteries

Storage and transport



CAUTION

Danger to user due defective device



→ Medical device may only be stored at an ambient temperature between 5°C and 35°C.



→ Do not expose the device to water.



→ Protect the device from strong sunlight or heat sources.

→ Do not use in dusty environments.



→ Medical device may only be stored at a relative humidity between 30-75%.

→ Medical device may only be stored at a relative pressure between 700-1060 hPa.

Environmental protection & disposal

This medical device conforms to the requirements of guideline 2011/65/EU of the European Parliament and Council (dated June, 8, 2011 and amendments) on the restriction of certain hazardous substances in electrical and electronic equipment.

This device may not be disassembled or by disposed as household waste once the treatment period is over. Please return the device to its manufacturer or supplier for proper disposal.

Under proper care the Mikti₂ has a product life cycle of up to 10 years. This does not exclude that repairs may be necessary during that timeframe.

Batteries and accumulators

Please dispose of batteries according to your local or national legal provisions (within the EU: guideline 2006/66/EG (dated September 6, 2006) of the European Parliament and Council).

Technical information

Display

LCD color screen

Resolution: 320x240 pixel

Connection ports

- 1x 3-pole socket on the front side to connect electrode cables or sensors for EMG-biofeedback (CH1)
- 1x 3-pole socket on the front side to connect electrode cables or sensors for EMG-biofeedback (CH2); **Not in usable**
- 1x 4-pole socket for PC connection cable (USB, 5000V checked/ optical decoupled)

Modes of operation

- EMG-Biofeedback

EMG-Range

- 0 – 300 μV with a resolution of 0.01 μV ... 0.25 μV
- Displaying of measurements both as numerical values and animations
- Sound rendering of EMG-measurements
- EMG-Range can be set manually, semi-automatic or fully automatic

Exercise phases

Tense phase: 0...255s

Relax phase: 1...255s

Exercise duration: 1...60min & continuous

Power supply

- 4x mignon AA batteries
- *or*
- 4x NiMH rechargeable batteries (2500mAh, 1.2V)

Safety features

- Protection class II, IP 20

Operating conditions



CAUTION



Danger to user due to defective device

→ Medical device may only be used at an ambient temperature between 5°C and 35°C.

→ Do not expose the device to water during therapy sessions.



→ Protect the device from strong sunlight or heat sources during therapy sessions.

→ Do not use in dusty environments.



→ Medical device may only be operated at a relative humidity between 30-75%.

→ Medical device may only be operated at a relative pressure between 700-1060 hPa.

Dimensions and weight

- L x W x H: 95x150x30 mm
- Weight (excl. batteries): 250 g

Storage of exercise data

Exercises are recorded and their data stored on the device. This includes the date, time and mode of operation of a training exercise as well as each individual EMG-value measured. Thus it is possible to check if the training schedule has been kept or not. Each patient is assigned only training sessions as conducted by them. This permits an objective analysis of the treatment process by the medical specialist responsible. The device is capable of managing up six different medical specialist, whom may use the device, each of which can be assigned up to six patients. Every patient may have up to six different training programs. Reading the stored data from the device should only be done by authorized persons (see manual for Mikti₂ PC software).

Application recommendation

EMG-biofeedback treatment with the Mikti₂ allows for selective training of muscles to enhance their coordination, endurance and strength.

Optimal training results can be reached with strength training by using semi-automatic EMG-Setting.

ELECTROMAGNETIC COMPATIBILITY (EMC) TABLES

Cable length of **K1 (MED) electrode cable**

	Cable length	Recorded length
K1med electrode cable	1.5 m	1.5 m

The use of longer cables can lead to increased electromagnetic emissions or reduced immunity to interference. Only use original manufacturer accessories.

Guidance and manufacturers declaration - electromagnetic emissions (Tab. 201 in accordance to DIN EN 60601-1-2)

The device is intended for use in the electromagnetic environment specified below. The user should assure that it is used in such an environment.

Emission test	Compliance	Electromagnetic environment guidance
RF emissions CISPR11	Group 1	The device uses RF energy only for its internal function. Therefore its RF emissions are very low and are not likely to cause any interference in nearby electronic equipment.
RF emissions CISPR11	Class B	The device is suitable for use in all establishments other than domestic and those directly connected to the public low voltage power supply network that supplies buildings used for domestic purposes.
Harmonic emissions IEC 61000-3-2	Not applicable	
Voltage fluctuations / flicker emissions IEC 61000-3-3	Not applicable	

**Guidance and manufacturers declaration — electromagnetic resistance
(Tab. 202 in accordance to DIN EN 60601-1-2)**

The device is intended for use in the electromagnetic environment specified below. The user should assure that it is used in such an environment.

Immunity test	IEC 60601- Test level	Compliance level	Electromagnetic environment - guidance
Electrostatic discharge (ESD) IEC 61000-4-2	± 6kV contact ± 8kV air	± 6kV contact ± 8kV air	Floors should be wood, concrete or ceramic tile. If floors are covered with synthetic material, the relative humidity should be at least 30%.
Magnetic field with a supply frequency (50/60 Hz) IEC 61000-4-8	3 A/m	3 A/m	Magnetic fields with power line frequency should match generic values as can be found in business offices and hospitals.

**Guidance and manufacturers declaration — electromagnetic resistance
(Tab. 204 in accordance to DIN EN 60601-1-2)**

The device is intended for use in the electromagnetic environment specified below. The user should assure that it is used in such an environment.

Immunity level	IEC 60601 - Test level	Compliance level	Electromagnetic environment - guidance
			<p>Portable and mobile radio devices should not be used any closer to the device or any part of it, including cables, than the recommended minimum distance calculated from the equation applicable to the frequency of the transmitter.</p> <p>Recommended distance:</p>
<p>Conducted HF-disturbance IEC 61000-4-6</p>	<p>3 Veff 150 KHz - 80 MHz</p>	<p>$V_1 = 10 \sqrt{P_{emk}}$ @ 150 KHz to 80 MHz</p>	<p>$d = (3.5/\sqrt{V_1}) \sqrt{P}$</p>
<p>Radiated HF-disturbance IEC 61000-4-3</p>	<p>3 V/m 80 MHz - 2.5 GHz</p>	<p>$E_1 = 10 \sqrt{P/m}$ @ 80 MHz to 2.5 GHz</p>	<p>$d = (3.5/E_1) \sqrt{P}$ for 80MHz to 800 MHz</p>
			<p>$d = (7/E_1) \sqrt{P}$ for 800 MHz to 2.5 GHz</p> <p>Where P is the maximum output rating of the transmitter in watt (W) according to the transmitter manufacturer and d is the recommended separation distance in meter (m). Field strengths from fixed radio transmitters, as determined by an electromagnetic survey should be less than the compliance level in each frequency range. Interference may occur in the vicinity of equipment marked with the following symbol:</p> 

NOTE 1: At 80MHz and 800 MHz, the higher frequency range applies.
 NOTE 2: These guidelines may not apply in all situations.
 The spread of electromagnetic fields is affected by absorption and reflection from structures, objects and people.

a) The field strength of fixed transmitters, such as cellular/cordless telephone base stations, mobile land radios, amateur radios, AM and FM radio broadcasts and TV broadcasts cannot be predicted with sufficient accuracy. Investigations are required to assess the electromagnetic environment at a location with any precision. If the measured field strength at the place the device is used exceeds the compliance levels described above, the device should be observed to verify normal operation. If abnormal performance is observed, additional measures may be necessary, such as reorienting or relocating the device.

b) Beyond the frequency range of 150kHz to 80MHz, field strength should be less than 10 V/M.

Recommended distances between portable and mobile high-frequency communication equipment and the device (Tab. 206 in accordance to DIN EN 60601-1-2)

The device is intended for use in an electromagnetic environment with limited high frequency disturbances. The user can help prevent electromagnetic interference by maintaining a minimum distance between portable and mobile radio communication equipment (i.e. transmitters) and the device as recommended below, in accordance with the maximum output of the communications equipment.

	Protective distance depending on the frequency of the transmitter in meter		
Rated maximum output of transmitter in W (Watt)	150 kHz to 80 MHz $d=(3.5/V_1)\sqrt{P}$	80 MHz to 800 MHz $d=(3.5/E_1)\sqrt{P}$	800 MHz to 2.5 GHz $d=(7/E_1)\sqrt{P}$
0.01	0.12	0.04	0.08
0.1	0.35	0.11	0.22
1	1.11	0.35	0.75
10	3.51	1.11	2.22
100	11.90	12.00	22.00

For transmitters rated at a maximum output not listed above, the recommended protective distance in meters (m) can be estimated by applying the equation to the frequency of the transmitter, where P is the maximum output power rating of the transmitter in watts (W) according to the transmitter manufacturer.

NOTE 1: At 80MHz and 800 MHz, the higher frequency range applies.
 NOTE 2: These guidelines may not apply in all situations.
 The spread of electromagnetic fields is affected by absorption and reflection from structures, objects and people.

Warranty

The original manufacturer provides statutory warranty for the device and all accessories produced by this same manufacturer from the date of the original consumer purchase.

If the product fails to function properly during its warranty period due to a defective part or faulty workmanship, the manufacturer or selling dealer will replace or repair the product.

All repairs must be performed by a service center authorized by the manufacturer. Any attempts to modify or repair the device performed by unauthorized persons will void this warranty.

Any malfunction or failure of the device caused by misuse of the product, including but not limited to, failure to provide reasonable and necessary maintenance, use inconsistent with the product's user manual or deviating from the instructions given by medical specialists is also not covered by warranty.

If problems with the device or its accessories arise, please contact the manufacturer:

Haynl-Elektronik GmbH
Magdeburger Str. 117a
39218 Schönebeck
Germany
Tel.: +49 (3928) / 69414
Fax: +49 (3928) / 76222
www.haynl.com
info@haynl.com

Advanced information for physicians and therapist



CAUTION

Danger to users due to incorrect therapy parameters

→ Only authorized persons may access advanced information and therapy settings

- The Mikt₂ offers extensive options by which an optimal and personalized therapy plan can be designed for every single patient.
- At the core of these options sits the main menu (see image below).
- To access the main menu press *button 1* while the device is booting. A gear icon is displayed next to *button 1* on the screen during the boot sequence to indicate this.
- Use the touchscreen to navigate the main menu, access sub-menus and configure options.
- Press button 1 to leave a submenu or return to a previous screen. On screen an arrow icon  is shown next to this button (see image). The icon itself has no touch function.
- To exit the main menu press button 1 while the first screen of the main menu is shown (see image below).
- It is necessary to enter an access code if the option code request is enabled. Enter the code via the touchscreen when a number block appears on screen.
- The access code is enclosed as a leaflet at the end of this manual. Please keep the access code secret so that patients do not unwittingly change therapy parameters.
- An invalid code will cause the device to restart.

The main menu is divided into three major sub-menus:

Therapy Settings

This sub-menu contains all parameters needed to fully configure therapy programs, such as mode of operation, duration of each individual trainings phase and properties of the electrical stimulation.

Treatment patters for common disorders or syndromes are predefined. Based on their diagnosis and up to date medical knowledge optimal treatment parameters can be devised for each individual patient.

System Settings

The options in this sub-menu concern more general aspects of the device. This includes the sound volume and animations used during training sessions as well as a number of parameters for operating the device.

Administration

This menu all therapists using the device, their assigned patients and stored exercise data of these patients can be managed.



Therapy Settings

This sub-menu provides extensive functions to configure training programs so that they fit the specific treatment of each individual patient who will use the device.

Initially a list of the programs assigned to the currently selected patient will be provided. Which patient is selected and the therapist they belong to is displayed in the upper

right corner of the screen. *Buttons 2 & 3* will switch forward through the list of patients and therapists. Once a program is selected a list parameters to be configured will be displayed (see image below). These parameters can be configured:

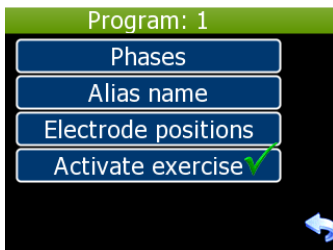

Phases

Each exercise consists of multiple repeating phases which includes phases for relaxing and tensing muscles. The duration of these training phases can be individually set in this sub-menu.

The duration of the entire training session with this program can also be set here. The maximum duration is one hour, beyond that training can be set to be continuous and only ends when the device is turned off.

Program name

This property defines the name assigned to the training program. It will be displayed in the *program selection* when patients have to choose which program they want to start. The name is also used in the list of programs shown in the *therapy settings* sub-menu.

The name is entered via the on-screen keyboard displayed after accessing this property.

The [Λ] and [123] buttons on the left side of the keyboard are used to switch to capital letters and number block.

To confirm the input simply return to the previous menu.

Electrode positions

This property defines if and which images for placing sensors or electrodes are shown to patients before the start of an exercise.

System Settings

This sub-menu includes the numerous settings defining the general behavior of the device:

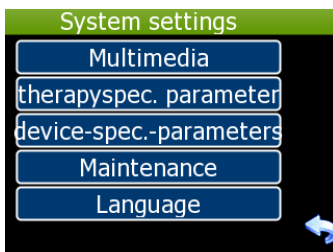

Multimedia

In this menu the sounds played during training sessions, namely *EMG-sound* and *voice output*, can be enabled. The *volume* of these sounds is set via a separated slider.

Therapy Parameters

Some therapy settings apply across multiple training programs and as such are set globally.

The *EMG-Setting* defines the method by which the EMG-Range is calibrated before the start of a training session. Available options are *Manual*, *Semi-automatic* and *Automatic*. A definition of these different modes can be found under section *Training* → *EMG-Setting*.

Device Parameters

This menu contains a number of options which define the general behavior of the device.

Patient Selection

If this option is enabled, the device will show a patient selection screen prior to the program selection screen. On that screen the user can choose the patient to whom the training data is to be assigned. Note that patients are grouped by their therapist.

Select patients and therapists by using the touchscreen. In case that this option is disabled the trainings data is assigned to the first patient of the first therapist instead. The device will also skip the patient selection screen and begin with the program selection screen instead (if more than one training program is active for the patient).

Access Code

This option enables or disables the access code request prior to accessing the main menu.

Please note that unauthorized persons may change therapy and device settings if no access code is required to enter the main menu.

Button Feedback

This option enables or disables the feedback sound when pressing a button or the touchscreen.

Lock Animation

If this option is enabled, the patient will not be able to change the animation shown during training.

EMG-Display

This option enables or disables the numerical display of EMG-value during training.

Maintenance

This menu features a number of technical options and functions for managing the data stored on the device.

Extras

This submenu contains settings such as the *Baud Rate* (data transmission speed) for PC-connections, *Screen Brightness* and toggling *Bluetooth* connectivity.

Delete Exercise Data

With this function all exercise data stored on the device can be deleted at once. This requires a manual confirmation to prevent unintended loss of data.

Please note that with this action all exercise data will be lost with no possibility of recovery.

Factory Reset

This function will reset the device completely to factory defaults. As such all exercise data, training programs, patient profiles therapist profiles and settings are lost. This includes all therapy and device settings.

Please note that this process is non-reversible and all data, programs and settings will be is lost with no possibility of recovery.

Language

This simple menu lets the user change the language used both during training sessions as well as all texts.

Administration

In this menu both therapists and patient profiles are managed. It also provides detailed statistic data for every exercise stored. Initially the screen will show a list of therapists (see image below).



Therapists

Press any label with a therapist's name to access their profile. Here their *name*, *surname* and *department* can be changed. To do so, press the button with a pencil icon next to the property.

Patients

To view the patients assigned to a therapist, press the button with the group icon next to the relevant therapist name. The screen will show a list of patients who are assigned to the therapist chosen. Accessing and changing a patient's details is done the same way as with therapists. Additionally, if there is any exercise data assigned to a patient, a button will be displayed next to his name in the list of patients. Pressing this button will display a list of this patient's recorded exercises. Pressing on the name of any such record will display details and statistical data of the exercise in turn.

Any exercise can be deleted by pressing the button with the waste basket icon. Scroll through the list of recorded exercises by dragging your finger over the vertical scroll bar.